

## Datasheet Iron265 SDI

### Iron265 SDI

2k Resolution, Small, Rugged,  
Low Power with Large Feature Set

### Innovative Approach

**Iron265 SDI** is an ultra-thin high speed, low-cost, low-power Global shutter CMOS camera with a Micro-BNC interface which supports up to 2k resolution high quality video at rates up to 60.0 fps.

### Intelligent Design

With an extremely compact form factor, the **Iron265 SDI** fits into small spaces. The superior sensor performance provides high quality images with great dynamic range, low noise and excellent low-light vision capabilities.

### Key Features:

- Up to 2k Resolution up to 60.0 fps
- Monochrome and Color sensor variation
- Up to 3.2 W power at full rate
- Full image processing feature set
- SDI standard compliant
- 1 SDI link
- C lens mounts available
- Commercial and Industrial grade options
- Full EMVA1288 report
- Full built-in self-test (BIT)
- Full built-in voltage testing
- Customization as per user requirements
- Tri-Level Sync Input
- TTL Strobe Output
- SMPTE Compliance – Several Standards listed

### Applications:

- Perimeter vision
- Low light surveillance
- Special Effects
- Virtual Reality
- 3D

# TECHNICAL DATA

General	
Pixel Size	3.45 $\mu\text{m}$ x 3.45 $\mu\text{m}$
Resolution	2048 (H) x 1080 (V)
Sensor Size	8.0 mm diagonal
Sensor	Sony Pregius IMX265
Sensor Type	CMOS
Output Interface	SDI
Supported Interface rates	HD-SDI or 3G-SDI
Interface Connector	Micro-BNC
Number of Connectors	1
Output Format	10-bit 4:2:2(Y'Cb'Cr') / RAW (Bayer)
Maximum Frame Rate	60.0
Video output	2k, 1080p or 1080i
Image Acquisition	Continuous
Camera Control	RS232 direct ASCII protocol
Electronic Shutter	Global
Monochrome / Color	Monochrome or Color
Temporal Noise	<2.2 e- at 25°C
Full Well Charge	9828 e-
Dynamic Range	>70.8 dB at 520 nm
Signal-to-Noise Ratio (SNR max)	40 dB at 520 nm
Quantum Efficiency (QE)	>63% at 520 nm
Shortest Exposure	10 $\mu\text{s}$
IR Filter (optional)	<ul style="list-style-type: none"><li>• UV cut below 400 nm</li><li>• IR cut above 700 nm</li></ul>
Exposure control	Automatic/Manual
Gain control	Automatic/Manual
Color Control	<ul style="list-style-type: none"><li>• RGB offsets</li><li>• Auto / Manual White balance</li><li>• LUT</li><li>• Color Multi-Matrix correction</li><li>• Cross Color Correction</li><li>• Gamma</li><li>• High performance De-Bayering</li><li>• Saturation Control</li></ul>
Image enhancement	<ul style="list-style-type: none"><li>• Defect pixel correction</li><li>• Gain (Analog / Digital)</li><li>• Auto / Manual black level</li><li>• Binning</li><li>• Auto Exposure / Gain</li><li>• Knee Function</li><li>• Noise reduction</li><li>• Edge enhancement</li></ul>

Additional on camera processing	<ul style="list-style-type: none"> <li>• ROI</li> <li>• Image flip</li> <li>• Frame counter</li> <li>• Operational Time Counter</li> <li>• Binning</li> </ul>
Power Input	• External 11 V - 28 V input
Power Consumption	<3.2 W at 24 V DC
Configuration software	Open Source GUI with a full feature set <a href="#">[link]</a>
Synchronization	Tri-Level Sync Input
Exposure Strobe output	Yes

Mechanical	
Dimensions (including lens mount)	44 mm x 44 mm x 35.3 mm (1.7" x 1.7" x 1.4")
Weight (without lens)	90 g (3.2 oz)
Lens Mount	C
Sensor Alignment	Active
Ingress Protection	Optional IP67 (with protective lens tube)

Environmental Conditions	
Operating ambient air temperature	Commercial : 0°C to +50°C ( 32°F to +122°F) Industrial : -40.0°C to +80°C ( -40°F to +176°F)
Operating ambient air humidity	10% to 90% RH non-condensing
Storage ambient air temperature	Commercial : 0°C to +55°C ( 32°F to +131°F) Industrial : -40.0°C to +85°C ( -40°F to +185°F)
Storage ambient air humidity	10% to 90% RH non-condensing
Operational Shock	Tested per MIL-STD-810G Method 516.6, 3-axis Shock 75G
Operational Vibration	Tested per MIL-STD-810G Method 514.6, 3-axis Vibration Category 20
MTBF	2,100,000 hrs @ 50C (Telecordia)

Certifications	
Electromagnetic - EMC standards	<ul style="list-style-type: none"> <li>• The European Council EMC Directive 2004/108/EC</li> <li>• The Unites States FCC rule 47 CFR 15</li> </ul>
EMC - Emission	<ul style="list-style-type: none"> <li>• EN 55022:2010 Class B</li> <li>• FCC 47 Part 15 Class B</li> </ul>
EMC - Immunity	<ul style="list-style-type: none"> <li>• EN 55024:2010 Class B</li> <li>• EN 61000-4-3</li> <li>• EN 61000-4-4</li> <li>• EN 61000-4-6</li> </ul>
Flammability	PCB compliant with UL 94 V-0
RoHS	Compliant with the European Union Directive 2011/65/EU (RoHS2)
REACH	Compliant with the European Union Regulation No 1907/2006

WEEE

Must be disposed of separately from normal household waste and must be recycled according to local regulations

# Iron265M-SDI-SC

Color options
M – Monochrome
I – Mono with IR Filter
N – Color w/o IR Filter
C – Color

Grade
S – Commercial
R – Industrial

Lens mount
C – C-Mount

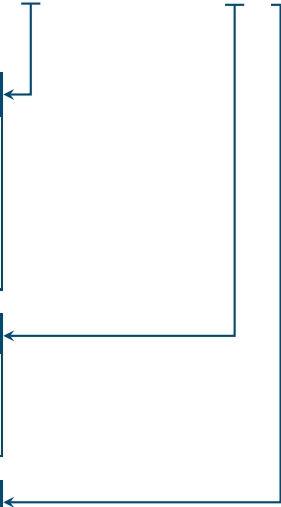

# SPECTRAL RESPONSE

## Monochrome

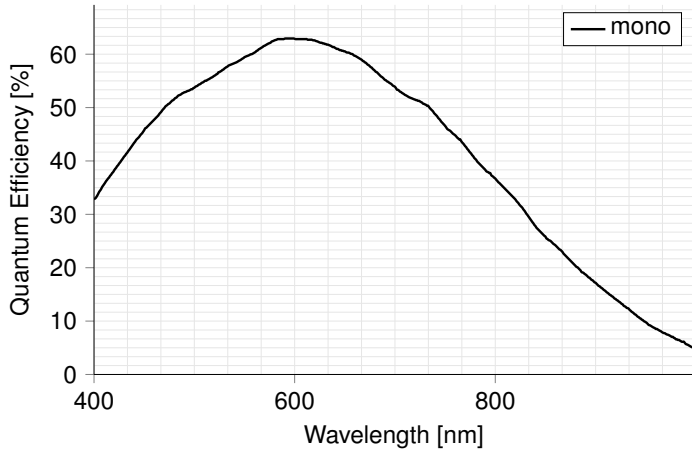

## Monochrome with IR Cut Filter

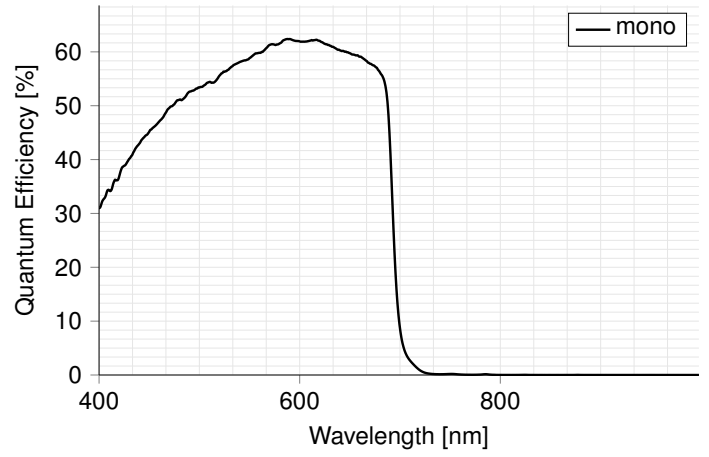

## Color

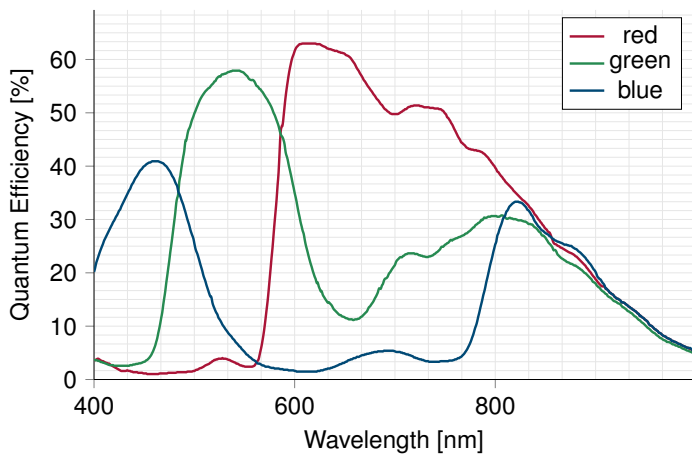

## Color with IR Cut Filter

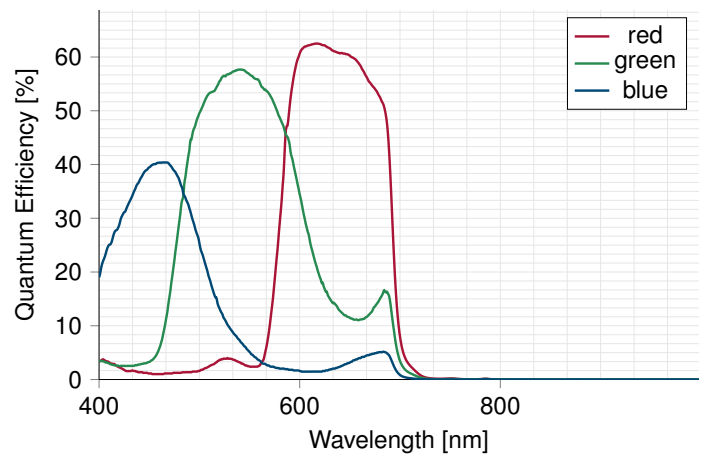

# GENERAL PURPOSE INPUT OUTPUT

## GPIO Pinout – 12 Pin Hirose Connector

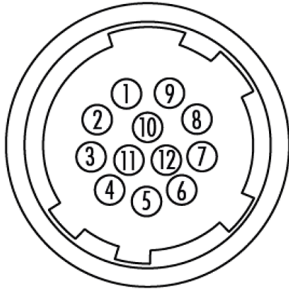

- |                    |                             |
|--------------------|-----------------------------|
| 1. DC Power return | 7. Strobe output (TTL)      |
| 2. DC Power        | 8. Tri-Level Sync input     |
| 3. RS232 RX        | 9. Reserved                 |
| 4. RS232 TX        | 10. Tri-Level/Strobe return |
| 5. Reserved        | 11. Reserved                |
| 6. RS232 Return    | 12. Reserved                |

The GPIO connector used on the camera is a 12-pin male Hirose connector. It is recommended to use a cable with a matching Hirose 12 pin female connector. Hirose's manufacturer's part number is listed below:

Product Name	Product Part Number
Hirose 12P connector, male	HR10A-10R-12PB
Hirose 12P connector, female	HR10A-10P-12S

# MECHANICAL DRAWINGS

## C-Mount

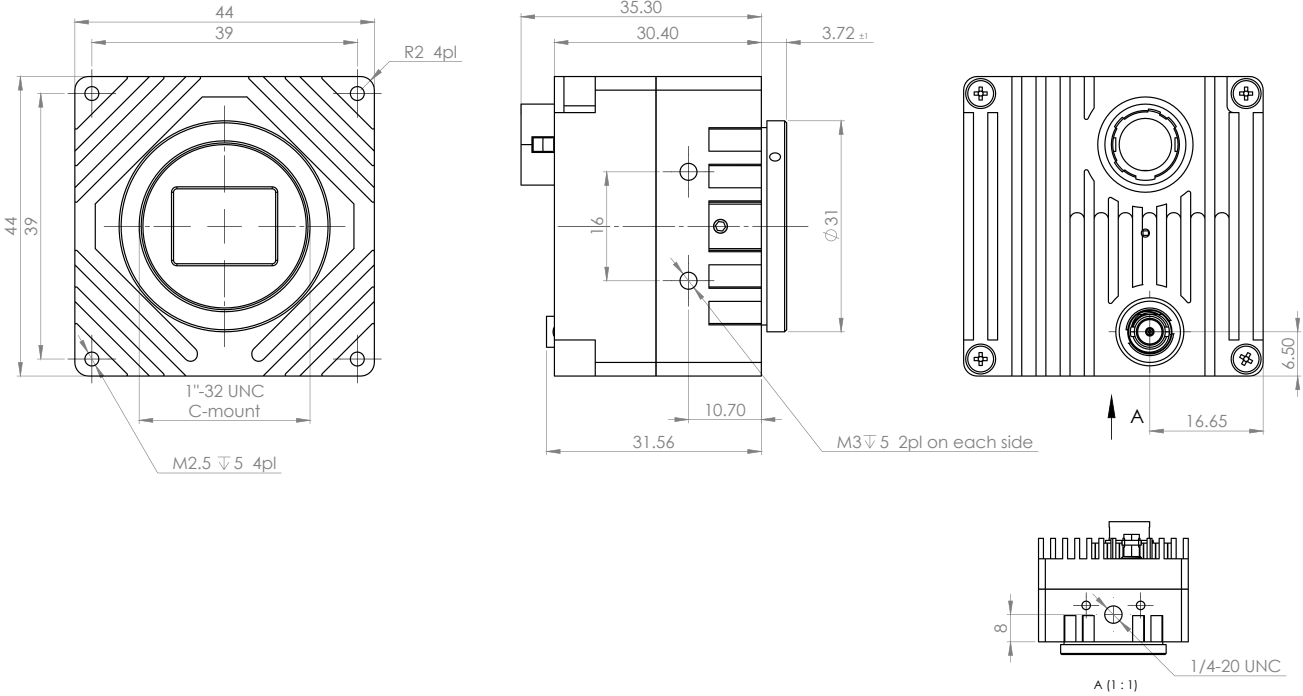

Dimensions are in millimeters.



## SUPPORTED VIDEO MODES

Mode	Video Standard	Supported Resolution	Supported FPS
HS-SDI	ST 292(ST 274)	1080i 10-bit 4:2:2/RAW	50, 59.94, 60
	ST 292(ST 2048-2)	1080p 10-bit 4:2:2/RAW 2K 10-bit 4:2:2/RAW	23.98, 24, 25, 29.97, 30 23.98, 24, 25, 29.97, 30
3G-SDI	ST 425-1(ST 274)	1080p 10-bit 4:2:2/RAW	50, 59.94, 60
	ST 425-1(ST 2048-2)	2K 10-bit 4:2:2/RAW	47.95, 48, 50, 59.94, 60
6G-SDI	ST 2081-10 M1,(ST 2036-1)	UHD 10-bit 4:2:2/RAW	Not Supported
	ST 2081-10 M1, (ST 2048-1)	4K 10-bit 4:2:2/RAW	Not Supported
12G-SDI	ST 2082-10 M1, ST 425-5(ST 2036-1)	UHD 10-bit 4:2:2/RAW	Not Supported
	ST 2082-10 M1, ST 425-5(ST 2048-1)	4K 10-bit 4:2:2/RAW	Not Supported
Analog CVBS	PAL	720 x 576	Not Supported
Quad 6G-SDI	ST 2082-11 M,(ST 2036-1)	UHDTV2 10-bit 4:2:2/RAW	Not Supported
		8K 10-bit 4:2:2/RAW	Not Supported
Quad 12G-SDI	ST 2082-12 M1,(ST 2036-1)	UHDTV2 10-bit 4:2:2/RAW 8K 10-bit 4:2:2/RAW	Not Supported Not Supported

# COMPATIBILITY

**KAYA Instruments** creates and maintains compatibility and interfaces for the most common and advanced vision image processing libraries and applications. Major support is available for **MVTec Halcon**, **National Instruments' LabVIEW** and **MathWorks' MATLAB**.

Supported vision standards:



Supported vision libraries:



Supported operating systems:



*Please check our website for an up-to-date list of other supported libraries and software package.*

International Distributor



Sky Blue Microsystems GmbH  
Geisenhausenerstr. 18  
81379 Munich, Germany  
+49 89 780 2970, [info@skyblue.de](mailto:info@skyblue.de)  
[www.skyblue.de](http://www.skyblue.de)

## KAYA Instruments

Please feel free to contact our sales team for pricing, availability, documentation or customization at our e-mails – we will be happy to provide assistance and consultation.

Sales Inquiries: [info@skyblue.de](mailto:info@skyblue.de)

Technical Support: [info@skyblue.de](mailto:info@skyblue.de)



© 2024 KAYA Instruments, Inc. All rights reserved. KAYA Instruments, the KAYA Instruments Komodo logo, JetCam logo, Predator, Iron and combinations thereof are trademarks of KAYA Instruments, Inc. in the United States and/or other jurisdictions. Microsoft Windows is a registered trademark of Microsoft Corporation. Other names are for informational purposes only and may be trademarks of their respective owners. KAYA Instruments is not liable for harm or damage incurred by information contained in this document.